

data sheet

model PMP203

PERIMax

pump series™

Features

- Low cost solution for light duty dispensing and metering
- Robust planetary gear box, 3 roller OEM design
- 9 tubing materials in stock to match your application
- Compatible with many chemicals and aggressive fluids
- Can pump slurries with high particulate content
- Pump head is factory sealed/welded
- Self-priming, panel mount, made in the USA
- Variable speed using our VFC3 flow controller
- Excellent dry running characteristics
- Fluid only contacts the inside of the tubing
- Many options and variations

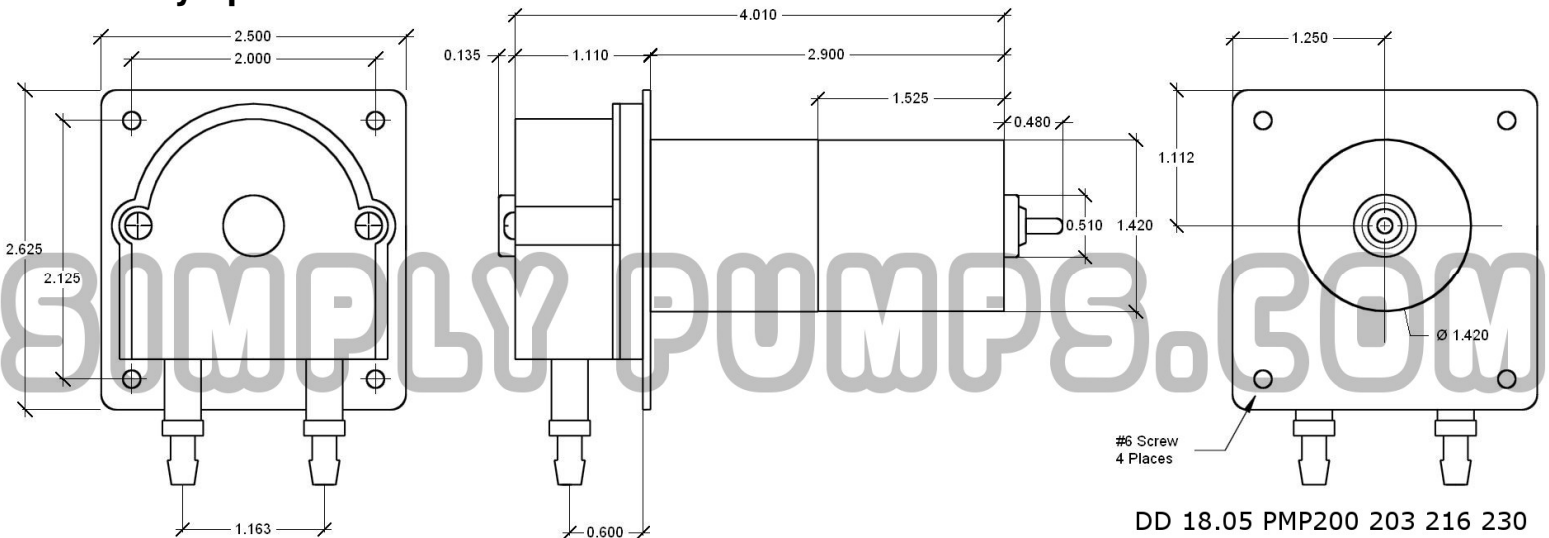
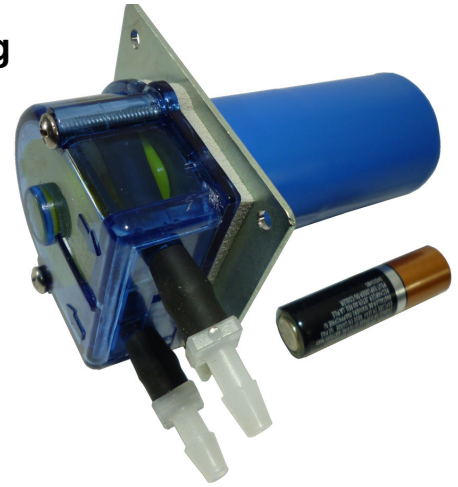

Specifications

- 12 VDC - 1.00 amp - 12 watt
- Maximum flow rate: 170 ml/min
- Maximum psi for firm tubing: 25
- Maximum psi for soft tubing: 10
- Maximum suction lift: 15 feet
- Dimensions: 4.000 x 2.625 x 2.500 inches
- Weight: 12.3 ounces
- Use with 0.125 inch ID tubing

The tubing type, fluid viscosity, and back pressure will determine actual flow rate, psi and current consumption. Not suitable for hot fluids or for high or continuous duty cycles.



PO BOX 677 Manor PA 15665 724 864 5959

Specifications are subject to change without notice. No liability or warranty implied by this information. Copyright © 2018 Simply Pumps
Revised 3/18/18 R1

data sheet

model PMP203

PERImax

pump series™

Stock Tubing Materials	Simply Pumps Suffix	Durometer Rating	Temperature Range °F		Coupler Material
			Low	High	
Norprene® Food Process A-60F	F	61	-75	275	Polypropylene
Norprene® Industrial Grade A-60G	N	61	-75	275	Polypropylene
Norprene® Chemical	C	61	-75	165	PVDF (Kynar)
Prothane II™	P	70	-35	175	PVDF (Kynar)
Tygon® Fuel and Lubricant F-4040-A	T	57	0	165	Polypropylene
Tygoprene® XL-60	G	60	-87	250	Polypropylene
Tygon® Long Flexible Life	E	56	-51	165	Polypropylene
Tygon S3™ E-3603 Laboratory	L	56	-51	165	Polypropylene
Versilic® Silicone SPX-50	S	50	-75	350	Polypropylene
Soft Viton® High Temperature	V	60	-25	400	PVDF (Kynar)

Replacement Pump Head Part Numbers

Stock Tubing Materials	200	203	216	232	233	235
Norprene® Food Process A-60F	PMPH200F	PMPH203F	PMPH216F	PMPH232F	NA	NA
Norprene® Industrial Grade A-60G	PMPH200N	PMPH203N	PMPH216N	NA	NA	NA
Norprene® Chemical	NA	PMPH203C	NA	NA	NA	NA
Tygon® Fuel and Lubricant F-4040-A	NA	PMPH203T	NA	NA	NA	NA
Tygoprene® XL-60	PMPH200G	PMPH203G	NA	NA	NA	NA
Tygon® Long Flexible Life	PMPH200E	PMPH203E	NA	NA	NA	NA
Tygon S3™ E-3603 Laboratory	PMPH200L	PMPH203L	NA	NA	PMPH233L	PMPH235L
Versilic® Silicone SPX-50	PMPH200S	PMPH203S	PMPH216S	NA	NA	NA
Soft Viton® High Temperature	PMPH200V	PMPH203V	PMPH216V	NA	NA	NA
Sealed replacement 200 series pump heads with tubing installed	3/16 x 5/16	1/8 x 1/4	1/16 x 3/16	1/32 x 5/32	3/32 x 7/32	5/32 x 9/32
	Tubing ID x OD					



Norprene, Tygon, Tygoprene, and Versilic are registered trademarks of Saint-Gobain Performance Plastics. Viton is a registered trademark of DuPont Performance Elastomers LLC. Vytex and Prothane II are trademarks of Randolph Austin Company



PO BOX 677 Manor PA 15665 724 864 5959

Specifications are subject to change without notice. No liability or warranty implied by this information. Copyright © 2018 Simply Pumps
Revised 3/18/18 R1